

schülke -t



hyclick® dispenser, suitable for specialised 500ml and 1.000 ml bottles with a built-in hyclick® pump

For the application of wash lotions and hand disinfectants



Be safe, it's easy

Our Plus:

- one-click system for an easy and fast bottle change
- optimal protection against contamination
- minimal cleaning thanks to the curved design
- adjustable dosage: approx. 1.5 ml and 3 ml
- easy installation

Description

Easy and exact dosage of wash lotions and hand disinfection products. Adjustable dosage allows the desired amount to be dispensed.

Change of bottle

When changing products, only the disposable bottle needs to be replaced.









Operating lever

The lever can be operated with the elbow or forearm. To change the bottle simply lift the lever and change, with one click, with one hand.

Cleaning and disinfection

The dispenser can be disassembled without tools. The smooth design enables easy cleaning and disinfection with e.g. mikrozid® universal wipes.

The following products are available in hyclick® compatible packaging*:

Product	Form of supply	Article no.
 desderman® pure 1.000 ml	10/ carton	70000814
 desderman® pure 500 ml	20/ carton	70000813
 desmanol® pure 1.000 ml	10/ carton	70001795
 desmanol® pure 500 ml	20/ carton	70000817
 esemtan® wash lotion 1.000 ml	10/ carton	70000133
 esemtan® wash lotion 500 ml	20/ carton	70000134
 s&m® wash lotion 1.000 ml	10/ carton	70000135
 s&m® wash lotion 500 ml	20/ carton	70000136
sensiva® wash lotion 1.000 ml	10/ carton	70000137
sensiva® wash lotion 500 ml	20/ carton	70000138

* These products are not available in every country. For more information please contact our local subsidiary or distributor.

Products

	Article no.
<input type="checkbox"/> hyclick® dispenser vario 500 ml / 1.000 ml	60000045
<input type="checkbox"/> hyclick® dispenser 1.000 ml	60000036
<input type="checkbox"/> hyclick® 500 ml adapter	60000035
<input type="checkbox"/> hyclick® drip-plate	60000037

Technical Data

Product size:	1000 ml 500 ml with 500 ml adapter
Adjustable dosage:	approx. 1.5 ml + 3 ml
Content level control:	constant, due to the transparent bottle
Material:	ABS plastic

hyclick® measurements:

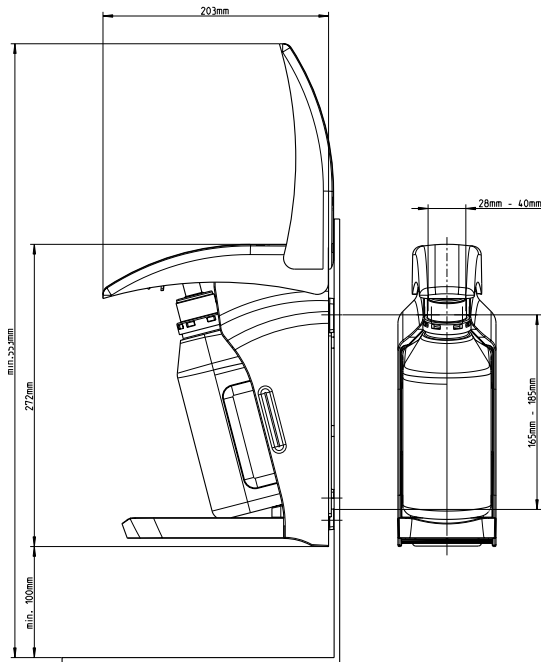

hyclick® measurements with 500 ml adapter:

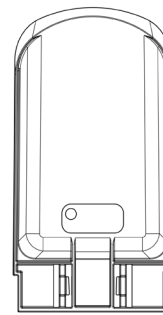
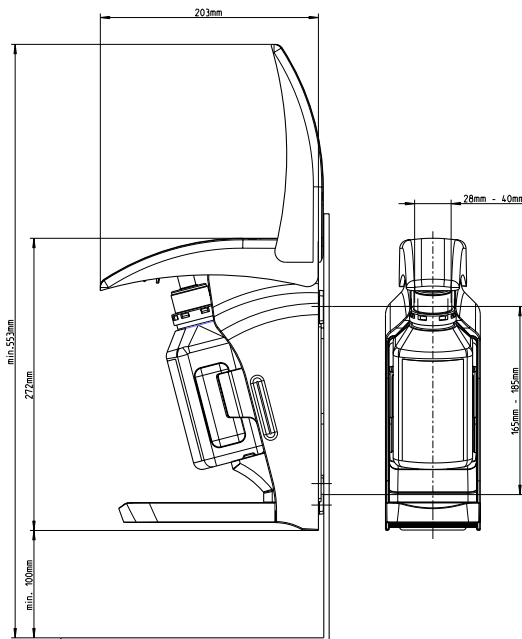

Drip-plate

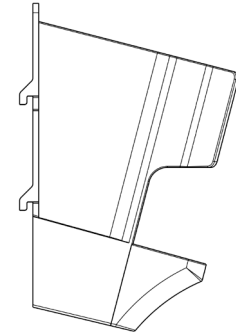

Adapter

Adjustable dosage:

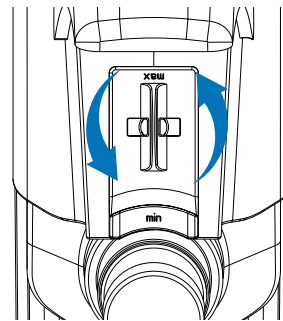

MIN

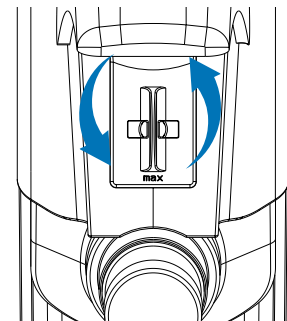

MAX



Schülke & Mayr GmbH is certified according to DIN EN ISO 9001 and DIN EN ISO 13485 (Reg.-No. 004567-MP23) and has a validated environmental system in accordance with the Eco Audit Regulation (Reg.-No. DE-150-00003).

Distributed by:
Germany
 Schülke&Mayr GmbH
 22840 Norderstedt, Germany
 Phone: +49 (0)40-52100-0
 Telefax: +49 (0)40-52100-318
 www.schuelke.com
 mail@schuelke.com